



Feature

High Speed Power Switching, Logic Level
 Enhanced Avalanche Ruggedness
 Lead Free, Halogen Free

			Ω
			Ω

Application

Load Switches
 Hard Switching and High Speed Circuit
 BLDC Motor

SOT-23

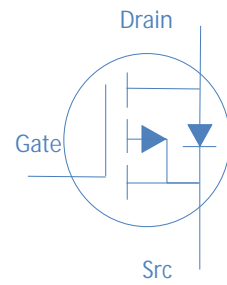
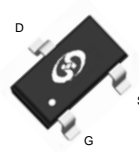

	θ		



μ
 μ

μ

Ω

Ω

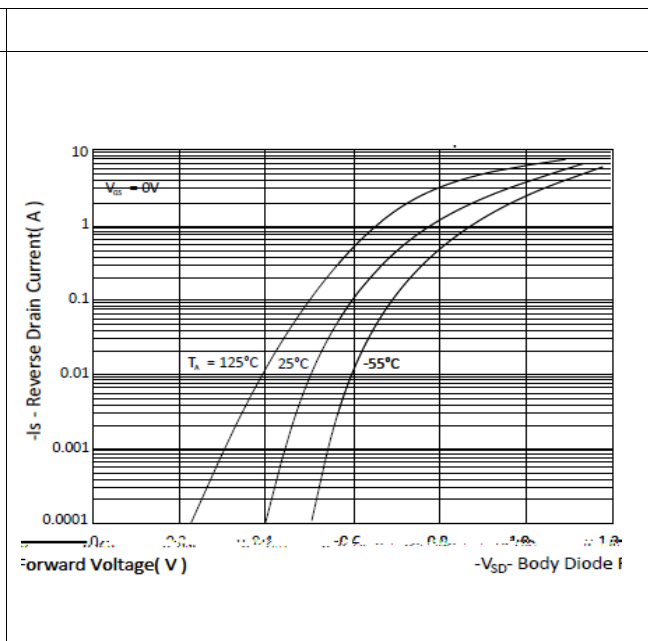
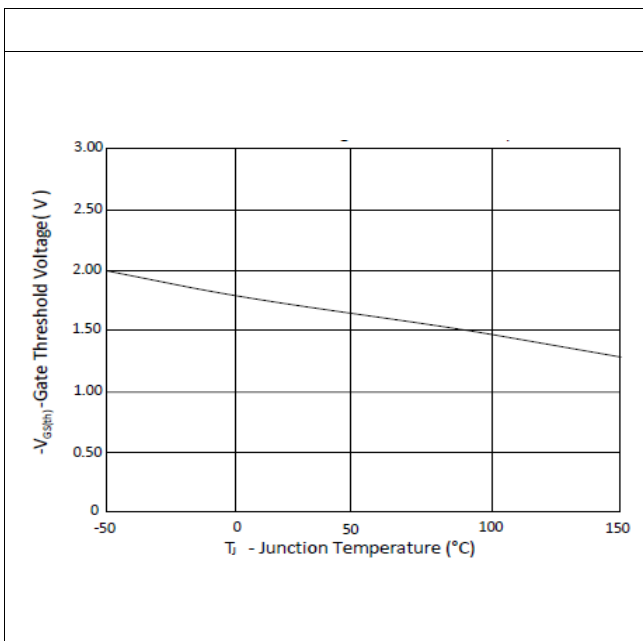
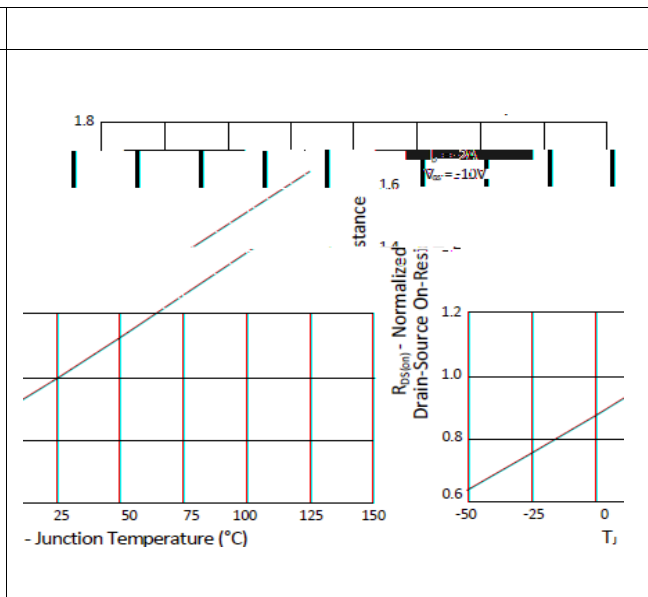
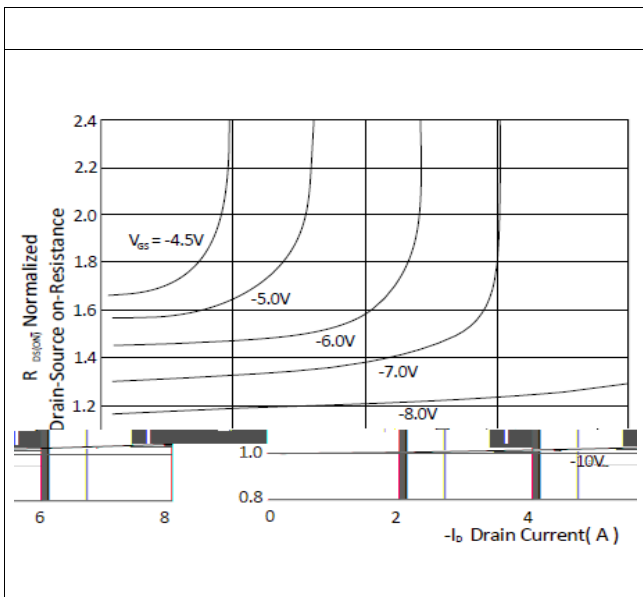
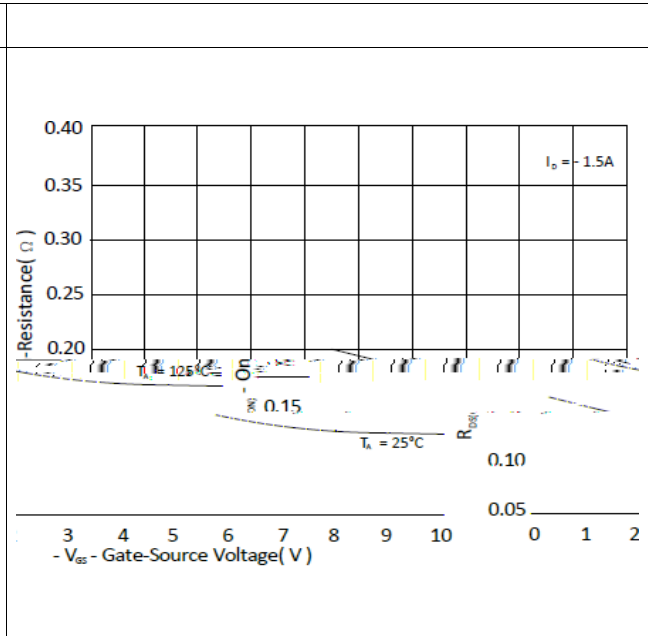
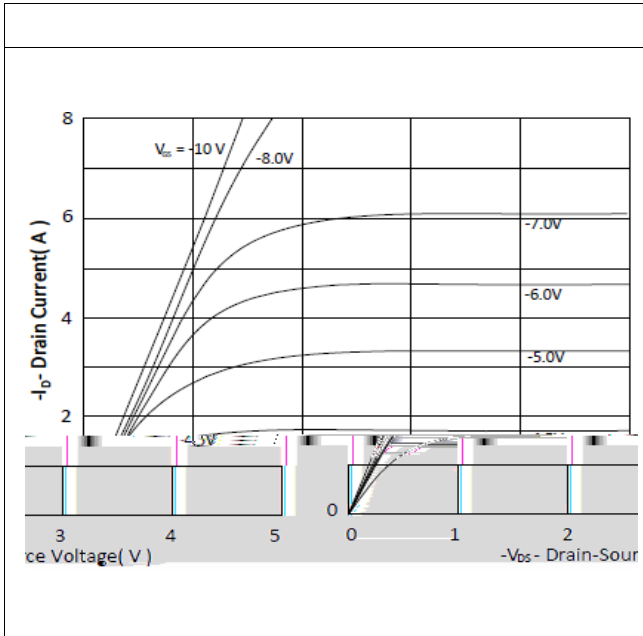

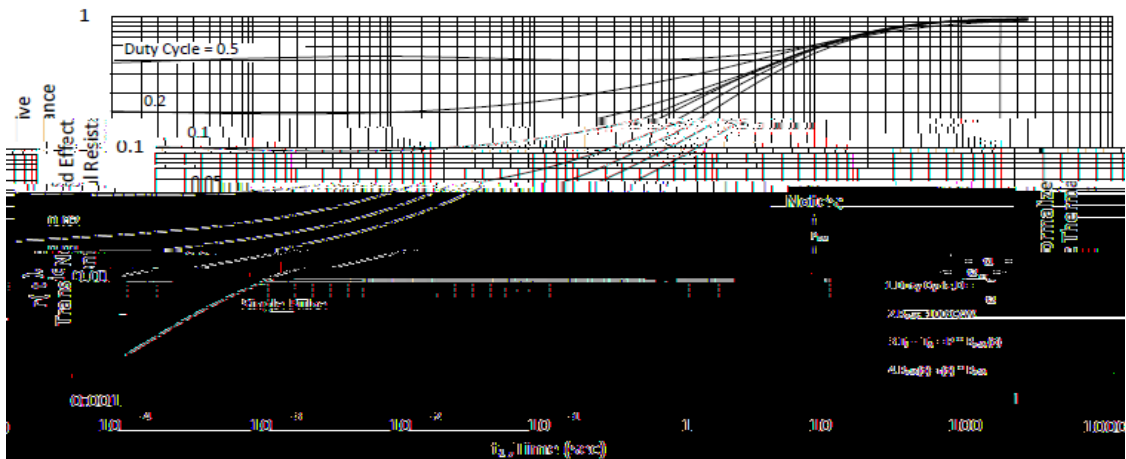
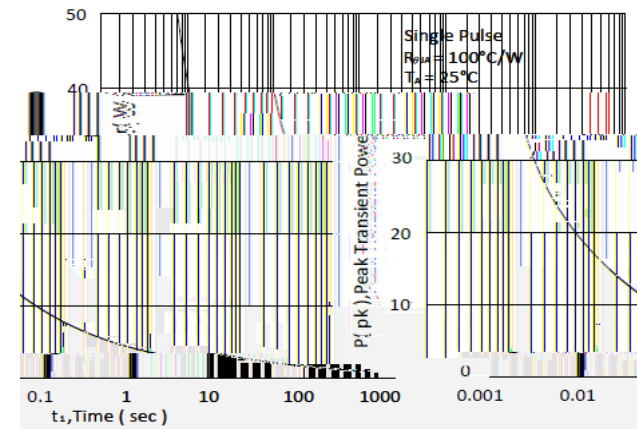
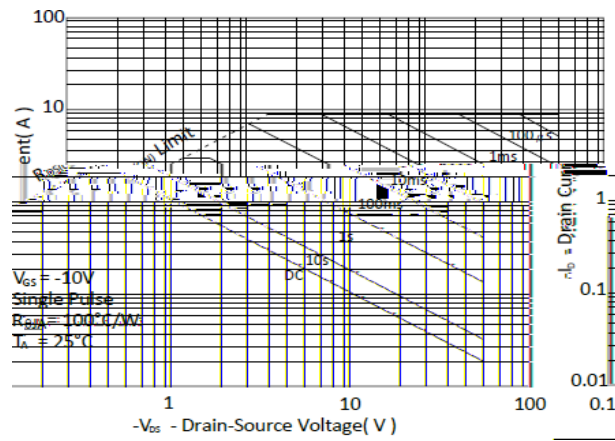
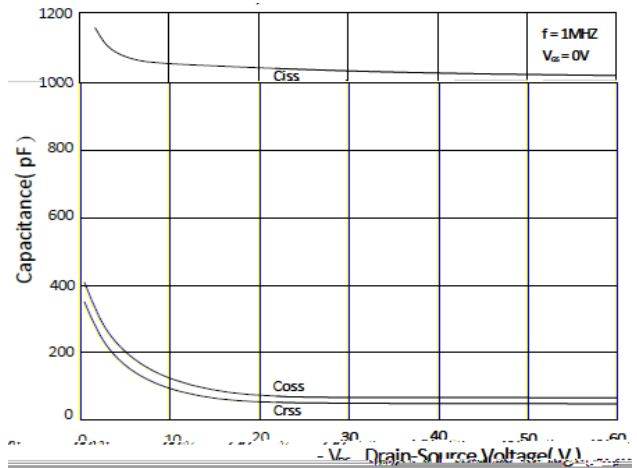
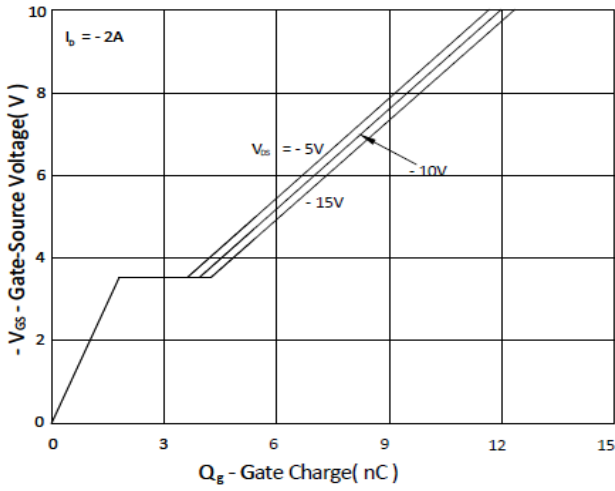

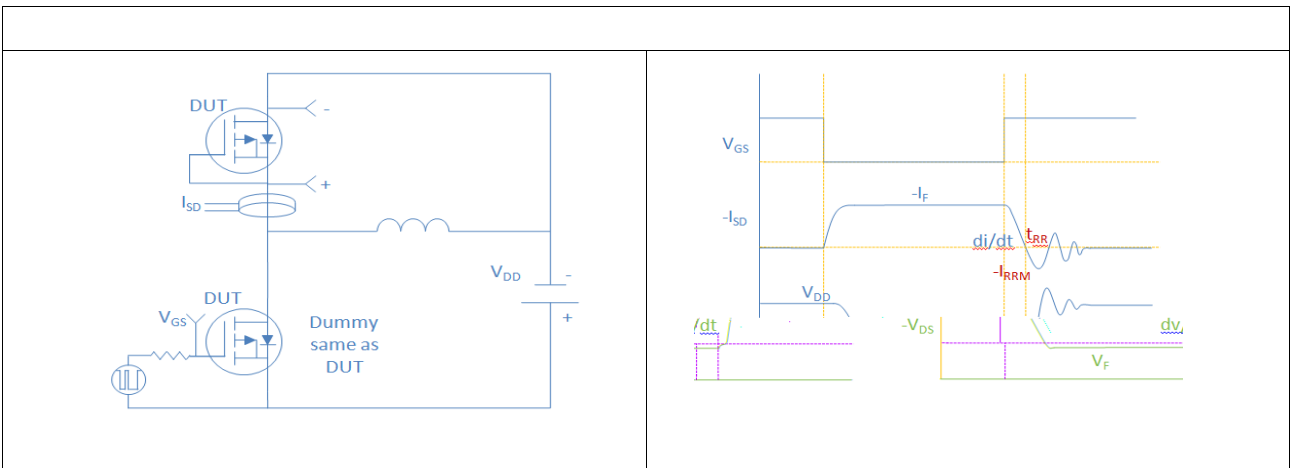
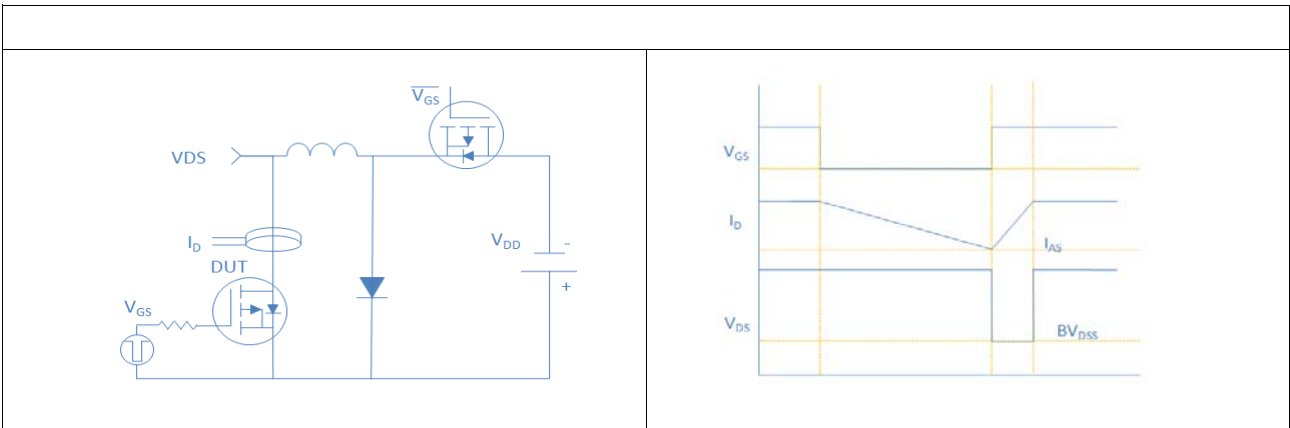
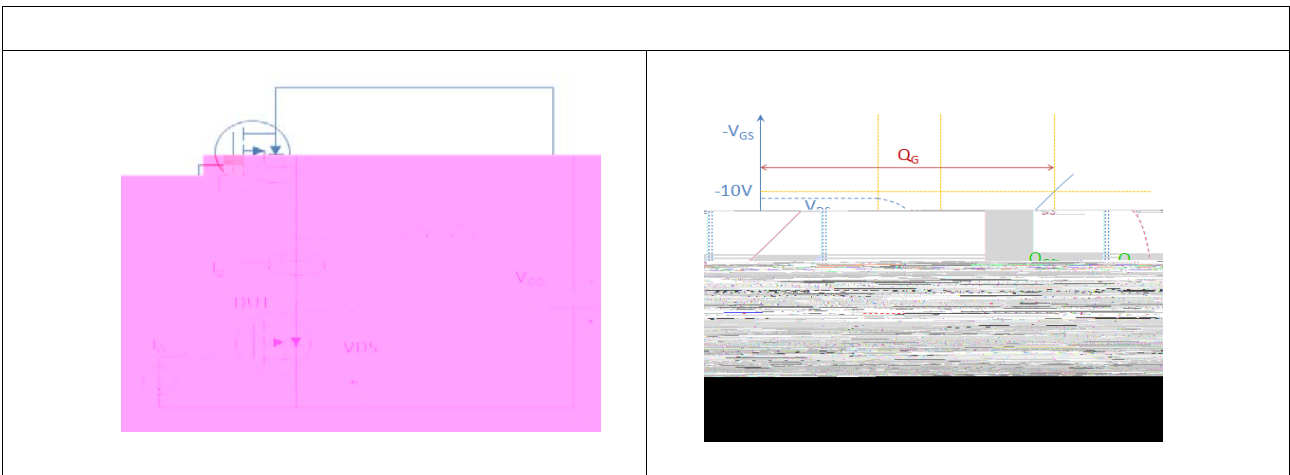
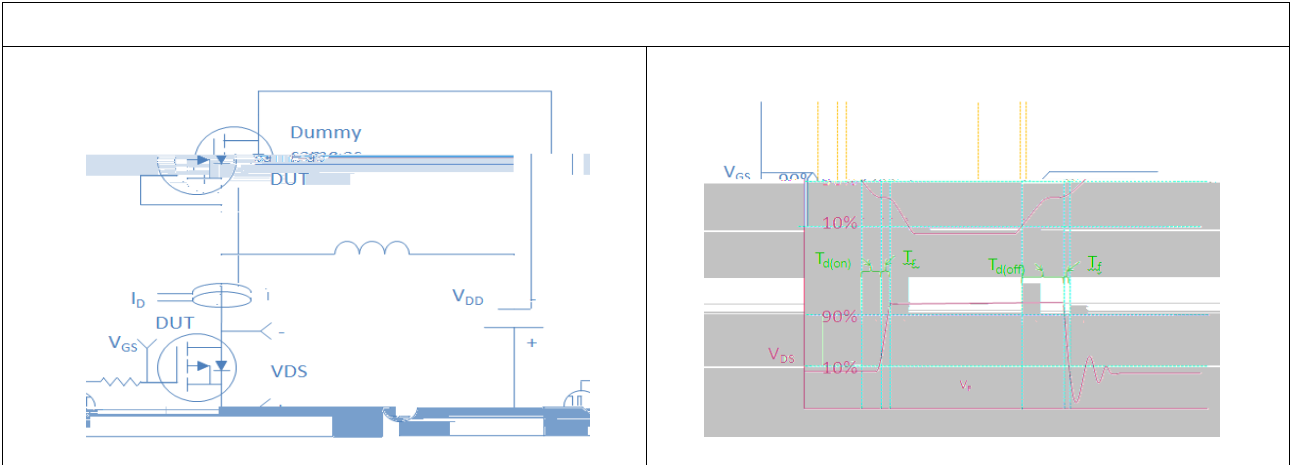

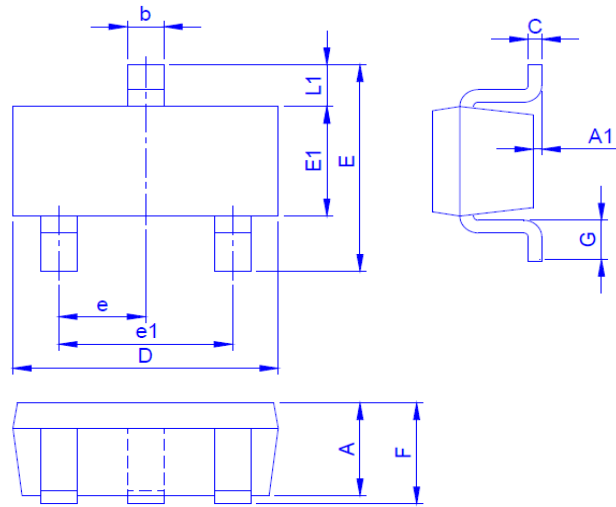

Dimension in mm

Dimension	A	A1	A2	b	C	D	E	E1	e	e1	F	G	L1
Min.	0.7	0		0.35	0.1	2.8	2.6	1.5	0.9		0.8	0.3	0.55
Typ.						2.9	2.8	1.6	0.95	1.9			
Max.	1.12	0.1		0.5	0.2	3	3	1.7	1		1.2	0.6	0.65